

Read all instructions BEFORE assembly and USE of product.
KEEP INSTRUCTIONS FOR FUTURE USE.

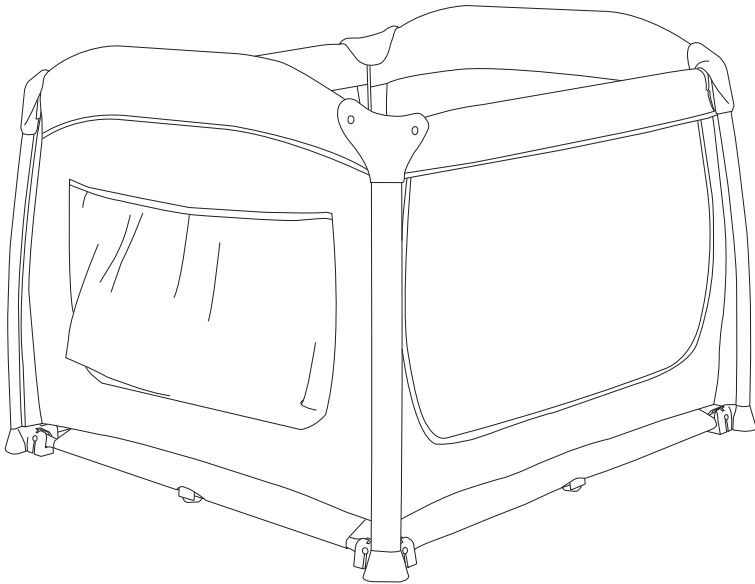

Room² Ultralight Playard Instruction Manual 75X Series





WARNINGS

**Read all instructions BEFORE assembly and USE of product.
KEEP INSTRUCTIONS FOR FUTURE USE.**

- Failure to follow these warnings and the instructions could result in serious injury or death.
- The product, including side rails, must be fully erected prior to use. Make sure latches are secure.
- Always provide the supervision necessary for the continued safety of your child. When used for playing, never leave child unattended.
- This product requires adult assembly. Be sure the playard is set up completely and properly before use.
- ALWAYS check that each of the four top rails are locked on both sides, the center of the floor is pushed down and the mattress is secured by snapping each of the straps around the base frame before placing child inside the playard.
- NEVER use the playard without the mattress securely in place.
- ALWAYS be sure the folding fabric handles are completely inside the slot at the center of the mattress and the green fabric handle is secured using the Velcro® flap before placing child inside the playard.
- When child is able to pull to standing position, remove bumper pads, large toys, and other objects that could serve as steps for climbing out.
- Discontinue use of the product when child is able to climb out or reaches the height of 35 in. (890mm).
- Do not use any attachments or items not included in this instruction manual with this playard.
- DO NOT leave child in product with side lowered. Be sure side is in raised and locked position whenever child is in product.
- To reduce the risk of SIDS, pediatricians recommend healthy infants be placed on their back to sleep, unless otherwise advised by your physician.
- NEVER LEAVE INFANT IN PRODUCT WITH SIDES DOWN. Infant may roll into space between pad and loose mesh side causing suffocation.
- AVOID SUFFOCATION. NEVER use a different sized mattress in this playard as this may result in suffocation. The mattress on this product is specially designed and sized to meet safety standards.
- AVOID SUFFOCATION. DO NOT use a water mattress with this product.
- Infants can suffocate.
 - In gaps between a mattress too small or too thick and product sides.
 - On soft bedding.NEVER add a mattress, pillow, comforter, or padding. Use only the mattress pad provided by Joovy.
- AVOID SUFFOCATION. Use ONLY the mattress provided with this product. NEVER add pillows, comforters or other items not recommended by Joovy with this item as suffocation may occur.
- AVOID STRANGULATION. DO NOT place product near a window where cords from blinds or drapes can strangle a child.

- Strings can cause strangulation! DO NOT place items with a string around a child's neck such as hood strings or pacifier cord. DO NOT suspend strings over product or attach strings to toys.
- Prevent possible strangulation or entanglement. Never use the playard sheet unless it fits securely on the playard mattress.
- POSSIBLE PINCHING HAZARD. When setting up the playard, use caution to avoid pinching your fingers on the top corners. Keep children away from the playard during set-up.
- Never use plastic bags or other plastic film as mattress covers not sold and intended for that purpose. They can cause suffocation.
- If refinishing, use a nontoxic finish specified for juvenile products.
- Discard all packaging materials properly. Do not allow children to play with them.
- IMPORTANT! Check this product for damaged hardware, loose joints, missing parts, or sharp edges before assembly and periodically during use. DO NOT use if any parts are missing, damaged, or broken. Contact Joovy at (877) 456-5049 for replacement parts and instructions if needed. Never substitute parts.
- Discontinue use of the playard should it malfunction or become damaged.

Please do not return this product to the store

If you experience any difficulty with the assembly or use of this product, or if you have a question regarding these instructions, please contact our Customer Service Department at (877) 456-5049 between the hours of 8:30 am and 5:00 pm Central Time.

Please Note: Styles and colors may vary

Assembling and Using your Playard

⚠ To ensure safe operation of your playard, please follow these instructions carefully.

Unpacking the Product from the Box

- Keep children away from playard while unpacking.
- Carefully remove playard and all parts from the box and plastic bag.
- Identify the parts (playard, mattress, foam pads (2), travel bag, and mattress sheet (NOT SHOWN IN FIGURE)) with the pictures in Figure 1.
- Remove all cardboard and plastic coverings from any areas of the product.
- Discard all packaging materials properly. Do not allow children to play with them.

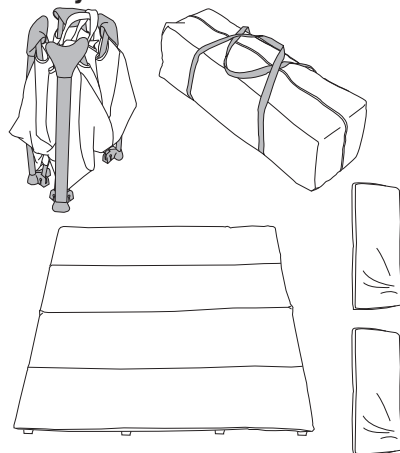

Figure 1

⚠ CAUTION

Adult assembly is required for this product. No Tools Required.

Unpacking from the Travel Bag/Assembling the Playard

- Keep children away from playard while unpacking.
 - Open the travel bag and remove the parts.
 - Release each of the Velcro® straps and slide them through the plastic ring as shown. See Figure 2.
 - Fold the Velcro® tabs over and secure them so they are out of the way.
 - Set the mattress and parts aside and orient the playard so it is resting on the feet and wheels.
 - If necessary, release the buckles on the sides of the playard.
 - WITH THE CENTER OF THE PLAYARD UP, PULL UPWARD ON EACH SIDE RAIL UNTIL IT LOCKS INTO POSITION. YOU WILL HEAR THE RAILS LOCK INTO PLACE ON BOTH SIDES OF EACH RAIL. See Figure 3
- NOTE: There is ONE mechanism that locks BOTH pieces of tubing on EACH side rail. See Figure 4.
- Make sure that the top rails have become rigid. If they haven't, pull up again on the rails until they are rigid. You may need to pull the folding fabric handles in the center of the floor higher.
 - Once you have locked the side rails in the up position, go back and check each side rail again to be sure they are all locked into position.
 - Holding one of the siderails up with one hand, use your other hand to push the floor down at each of the 4 side walls until the floor is completely flat on the ground. See Figure 5.
 - Locate the green fabric handle in the center of the playard floor. Unfasten the Velcro® flap, place the green fabric handle flat on the floor and fasten the Velcro® flap to cover the handle. See Figure 6.
 - Locate the mattress and the (2) foam mattress pads.
 - On the mattress, if necessary, open each of the zippers on the underside of the mattress near the end.
 - Insert a foam mattress pad into the opening pocket created when opening the zipper. Pull the zipper closed. See Figure 7. Repeat this procedure on the other side.
- NOTE: If you wish to use the mattress sheet, please reference the section for attaching the sheet before proceeding.
- While standing at the back of the playard (the side with the solid wall), set the mattress inside the playard with the straps and zippers facing down and the opening in the center of the mattress in a horizontal position. See Figure 8.
 - Locate the straps with the snaps near the four corners of the mattress.
 - Slide a strap through the slot in the floor of the playard, loop it around the base frame tube and secure the snap to attach the mattress to the playard. See Figure 9. Repeat this step on the other three corners.

WARNING

Be careful not to pinch your fingers on the top corners during assembly. ALWAYS ensure that all side rails are locked into position before using this product. ALWAYS secure the mattress to the playard floor by snapping each of the straps to the base frame. NEVER use items not recommended by Joovy with this product.

NOTE: The playard comes equipped with wheels on two sides for easy transport. Be sure to lift the opposite side of the playard off of the floor when pulling the product on its wheels to avoid damaging your floor.

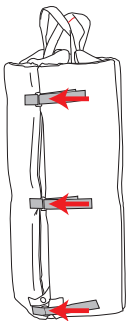

Figure 2

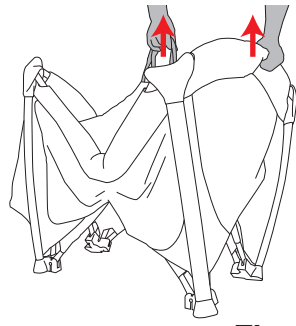

Figure 3

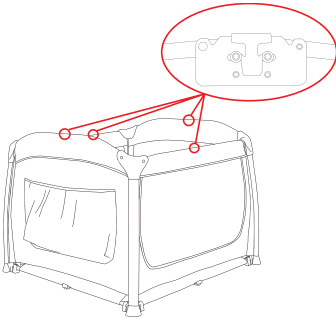

Figure 4

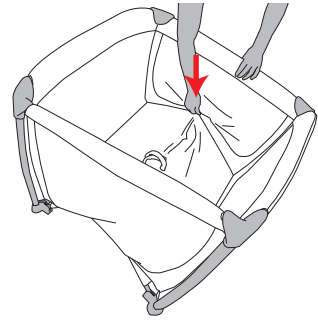

Figure 5

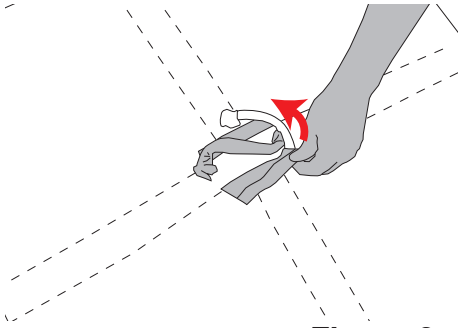

Figure 6

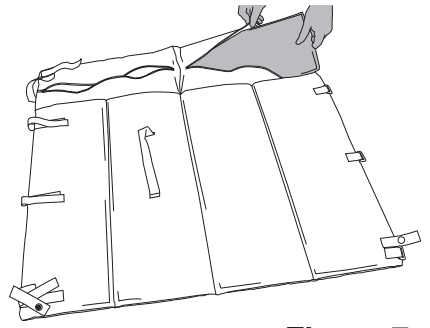

Figure 7

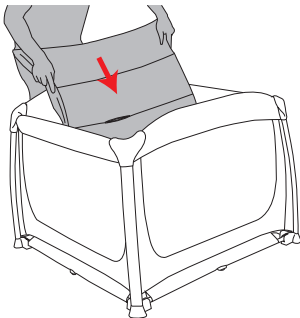

Figure 8

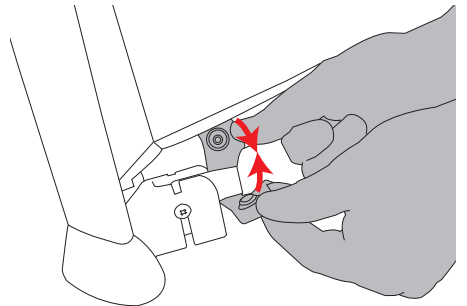

Figure 9

Attaching/Removing the Mattress Sheet

Note: This product comes complete with a custom fit mattress sheet. To use the sheet with your playard, please follow the instructions below.

Before attaching the mattress to the playard, simply fit the sheet over the mattress with the corners in place. Then, feed the mattress straps with the snaps through the slots in the sheet and then through the slots on the playard floor. Loop the straps around the base frame tube and secure the snap as detailed in Figure 10.

To remove the mattress sheet, detach the snaps and feed the straps through the slots in the floor and the sheet. Then, simply pull the sheet off of the mattress.

WARNING

Prevent possible strangulation or entanglement. Never use playard sheet unless it fits securely on the playard mattress.

Operation of the Quick Fold

NOTE: The quick fold mode allows you to fold the playard quickly and easily without completely disassembling. You must remove the mattress sheet before using the quick fold.

- With the sheet removed, stand behind the back of the playard (the side with the solid wall). Reach inside the opening in the center of the mattress and locate the black fabric handle.
- Pull upwards on the black fabric handle ONLY to lift the floor. Be sure the handle is pulled upward sufficiently to raise the floor. See Figure 11.
- With the center of the floor pulled up, locate the button at the outside center of one of the side top rails. NOTE: The button is sewn inside the fabric near the center of each top rail. See Figure 12.
- Pull upward on the top rail and squeeze the button. Then push down on the top rail until the locking mechanism is released on BOTH sides of the top rail. See Figure 13. NOTE: If the rail tubes do not unlock, do not force them. Lift the center of the floor higher and try again.
- Once you have successfully released BOTH tubes and folded that top rail, repeat this procedure on the opposite top rail until both of the side top rails have been folded.
- Pull the front of the playard towards you until the playard is folded in half. See Figure 14.
- Locate the male and female buckles on one side of the playard and fasten the buckles to secure the playard together. See Figure 15. Repeat this procedure on the other side.

NOTE: DO NOT force the playard. If the unit will not fold, look for a partially latched top rail and push the button in to release the rail.

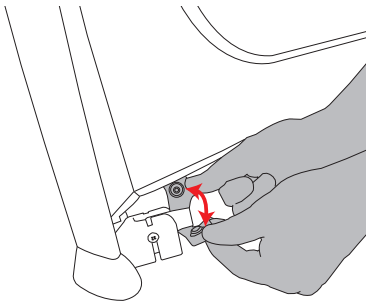

Figure 10

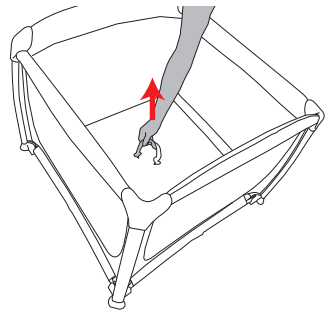

Figure 11

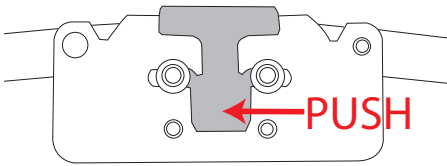

Figure 12

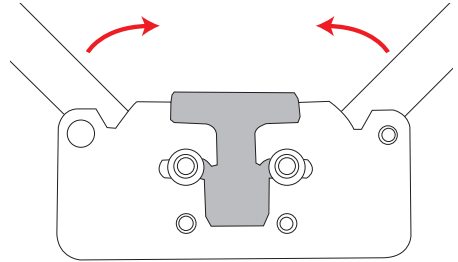

Figure 13

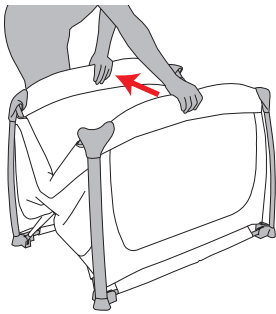

Figure 14

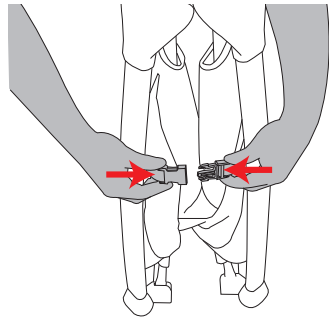

Figure 15

To Completely Fold and Pack the Playard

- Detach the snaps on the straps at the corners of the mattress from the base frame tube and guide each of the straps through the slots in the floor to release. See Figure 16.
- Lift the mattress from the playard and set it aside. If necessary, remove the mattress sheet.
- Unfasten the Velcro® flap near the center of the floor to expose the green fabric handle. Pull upward on BOTH fabric handles near the center of the playard floor. Be sure that the center of the floor is pulled up all the way. See Figure 17.
- With the center of the floor pulled up, locate the button at the center of one of the top rails.
NOTE: The button is sewn inside the fabric near the center of each top rail.
- Pull upward on the top rail and squeeze the button. Then push down on the top rail until the locking mechanism is released on BOTH sides of the top rail. See Figure 18. NOTE: If the rail tubes do not unlock, do not force them. Lift the center of the floor higher and try again.
- Once you have successfully released BOTH tubes and folded that top rail, repeat this procedure on the other top rails until all four top rails have been folded.
- Gather the playard together until it is compact and completely folded. See Figure 19.
NOTE: DO NOT force the playard. If the unit will not fold, look for a partially latched top rail and squeeze the button in to release the rail.
- Lay the mattress on the floor with the straps and zippers facing down. Lay the folded playard frame on the mattress and fold the mattress around it. See Figure 20.
- Locate the Velcro® straps on the end of the mattress, thread them through the plastic rings on the other side of the mattress and attach them. See Figure 21.
NOTE: It is not necessary to remove the foam mattress pads from the mattress. The playard bag was designed to accommodate the product and mattress at its full height.
- Place the travel bag on the floor and open the zipper. Place the playard in the bag. See Figure 22. Once the playard is completely inside the travel bag, close the zipper.

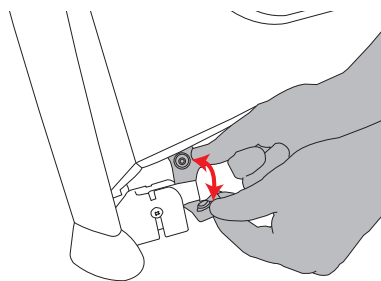

Figure 16

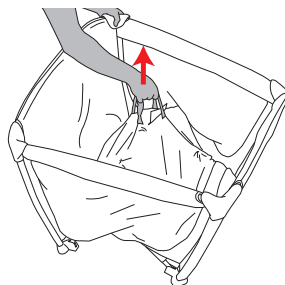

Figure 17

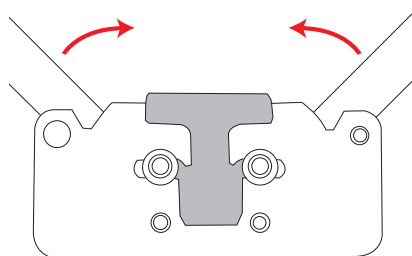

Figure 18



Figure 19

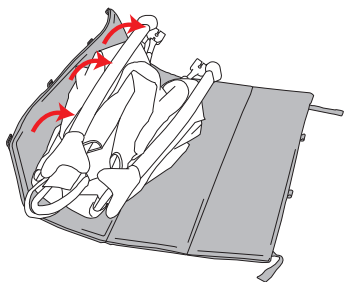

Figure 20

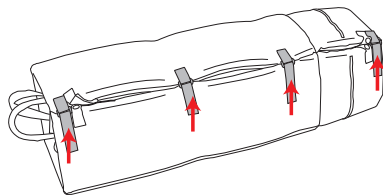

Figure 21

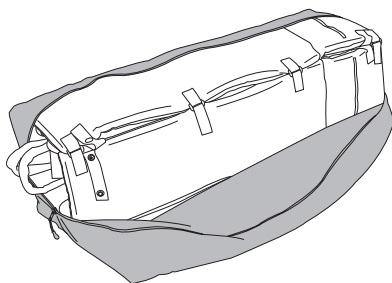

Figure 22

Maintenance

All of the fittings, locks, rivets, and other hardware and plastic parts on the playard should be inspected periodically to insure that they are secured properly and not damaged or malfunctioning. The straps and fabric items and their stitching should also be inspected periodically to ensure that they are secured properly and not loose, torn or otherwise damaged. All moving parts, such as wheels, and hinges should also be checked periodically to ensure they are operating properly.

If using this item at the beach you must clean sand off of ALL the parts before packing it into the travel bag. Getting sand in the top rail locks may damage the function.

Any missing, broken, or worn components should be replaced immediately, and the playard should not be used until they are replaced. Only original manufacturer's components should be used. If needed, please contact Joovy at our toll-free phone number.

Cleaning

The fabric material on this product can be cleaned using mild household soap or detergent and warm water on a sponge or clean cloth. Always allow the fabric to completely air dry before using the product.

The frame and wheels should always be kept clean and free of dirt and foreign matter. Use a sponge or cloth dampened with warm water and a mild detergent cleaner to clean these parts if necessary.

See the care label sewn onto the sheet for detailed cleaning instructions.

SATISFACTION GUARANTEED

We want you to be completely satisfied with your purchase of this product. Should you experience any difficulty in assembling or using this product, or if you have any questions - Please contact our Customer Service Department at (877) 456-5049 between the hours of 8:30 am and 5:00 pm Central Time.

Please log onto www.joovy.com to register your new Joovy product.



Strollers

Playards

Toys

Accessories

Store

what's new



Free Shipping!
on strollers
and toys
On orders shipped domestically only.



[about joovy](#) | [product support](#) | [where to buy](#) | [register your product](#) | [contact joovy](#)

© 2008 joovy Contact: customerservice@joovy.com 2919 Cantos Street, Dallas TX 75226 (877) 456-5049 Fax:(214) 761-1774

Look for these other Joovy products



**ergo
Caboose™**



Zoom™ 360



Big Caboose™



2919 Canton Street • Dallas, TX 75226 • (877) 456-5049 • Fax: (214) 761-1774
E-mail: customerservice@joovy.com • Website: www.joovy.com

©Joovy 2010 • Document Version 051210